

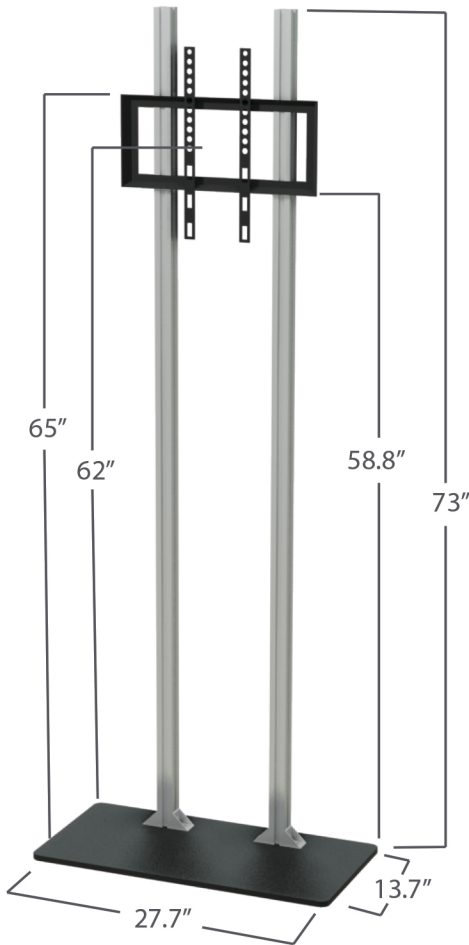

Large Monitor Mount Setup WLM-Mount-L



Description

Designed to fit any Waveline Display, these mounts achieve a "floating" screen experience. Simply slide the mount behind the display, and attach your screen on the front. Graphics can include a cut-out for easy access, or you can do your own cut as needed. Kit includes wooden base plate, aluminum post and mount.









Dimensions

Product Weight: 21lbs	Shipping Weight: 24lbs
Assembled Size: 27.5"w x 73"h x 13.7"d	Box Dimensions: 39" x 15" x 5"

Monitor Specifications

Holds Monitors up to 55" or 50 lbs
Up to VESA 400x400

Parts

- A - x10 M8 Allen Screw 
- B - x8 Flat Gasket 
- C - x4 M8 Nut 
- D - x2 M5 Philips Screw 
- E - x4 M8 Philips screw & Gasket 
- F - x4 Bracket-to-Monitor Screws: M5, M6, & M8 screws included. Check your TV for specs 
- G - x4 L-Bracket & Cap 
- Allen Keys 
- Philips Screwdriver 



Monitor Brackets x2



Monitor Plate



Vertical Poles x4



Base



Carry Bag

Large Monitor Mount Setup

WLM-Mount-L

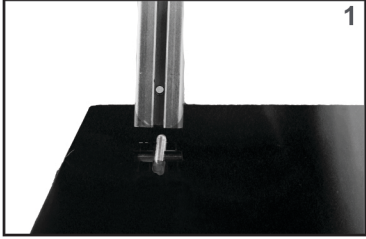

Secure the poles to the base using screw **A**

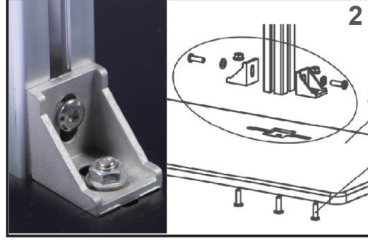

Attach the triangular supports to sides of poles, using **A** screws, **B** gasket and **C** nuts.

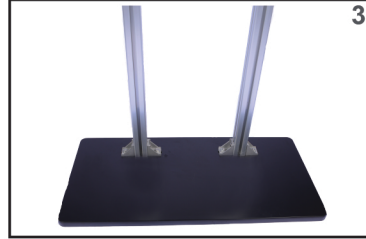

Secure screws with Allen wrench

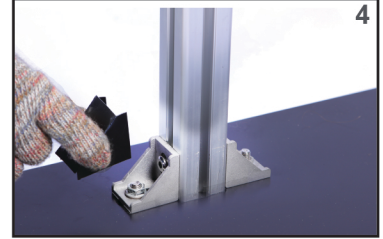

Attach caps to triangular supports

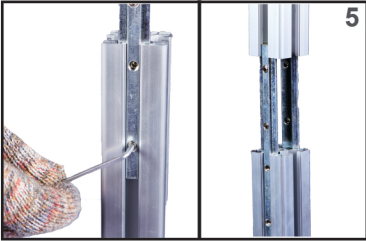

Connect the pole extension using allen key to secure connector insert



Attach the Mount Plate to the pole, use Philips **E** screw



Place the Monitor Stand behind your display, slide the base forward

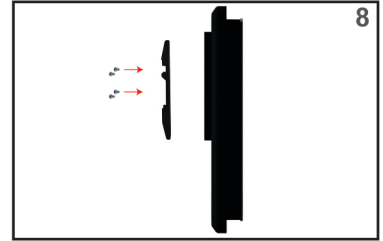

Mount the brackets to the back of the monitor with 4 **F** screws

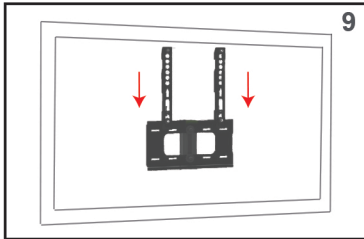

Slowly hang the Bracket onto the Monitor Plate through the opening on the graphic

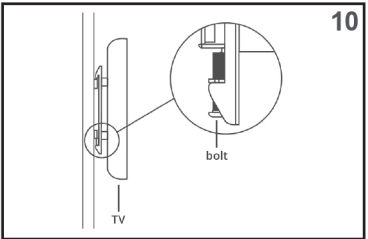

Secure the bracket to the Monitor Plate by tightening the safety screws **D**



Enjoy your display!